

G1888

Presentation:

The BASS-F series offers a professional passive/active flyable subwoofers range becoming the perfect choice for sound reinforcement challenges demanding high SPL and natural-sounding bass response designed to enhance the ultra-low bass of an existing PA system.

This G1888 is on a bass reflex configuration and constructed of 18mm birch plywood featuring a 18" loudspeaker with 4" voice coil delivering a nominal power handling of 1200W rms at 8 Ohms each giving low-ranging yet clearly defined bass response and rendering impulses with great accuracy in a very compact and robust enclosure.

A perforated steel grille protects the loudspeaker and there are two side handles as well as four points in the rear for castors mounting. The enclosure has an integrated rigging system flyware and Ø9.8mm ball pins w/ stainless steel lanyard with PVC to facilitate ease of mounting and there is a metal rigging frame that allows the system to be used ground stacked or individually flown to increase its versatility combined with the LA88 (2x 8" line array speaker).

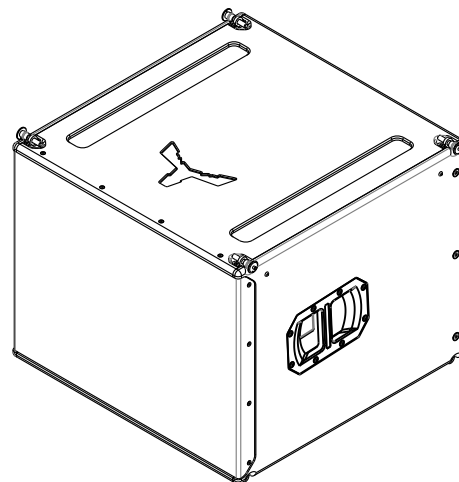

Features:

- Bass reflex & flyable PASSIVE subwoofer
- Suited for 2x 8" line array speaker - LA88
- 1x 18" (4in VC) LF EU transducer, 1200W AES
- Versatile, compact and coherent subwoofer
- 2x NL4 connected in parallel
- Optimized for high SPL output
- Made for an impact bass
- Prepared for stacking and flying operation
- Rugged and durable 15mm birch plywood
- Powder coated custom perforated steel grille

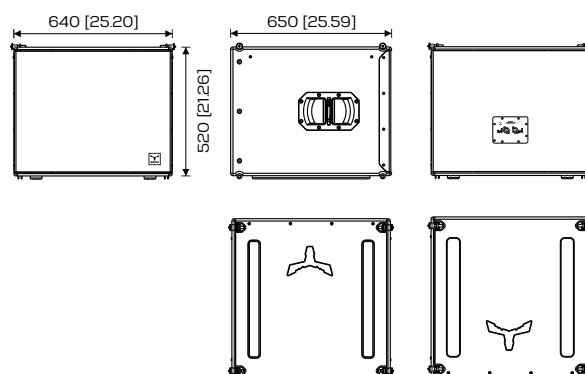

Dimensions in mm [in]

Technical specifications:

Acoustical

Type	Flyable and compact passive subwoofer
Enclosure design	Bass reflex
Power rating (RMS/Peak)	1200W / 4800W
Frequency range	32 - 200Hz (-10dB)
Nominal impedance	8 ohm
Transducer type	1x 18" LF (4in VC) EU transducer
Crossover frequency	35Hz Butterworth 18dB (low cut filter)
SPL (1W/1kHz)	135dB @ 1m
Sensitivity	96dB
Connector	2x NL4, parallel-connected

Mechanical

Enclosure	18mm birch plywood, rugged polyurea coating
Grille	Custom perforated metal grilles w/ acoustic foam
Color	Black or white textured
Hardware	Integrated rigging flyware Ø9.8mm ball pins w/ stainless steel lanyard with PVC 2 wood feet, 2 recessed side handles
Dimensions	Prepared for castors and for stacking
Weight	640x650x520mm 25.20x25.59x21.26in 52Kg 114.64lb

