

Base de dados:	Guilhotina:
Ordem:	Quinadora:
Referência:	Puncionadora:

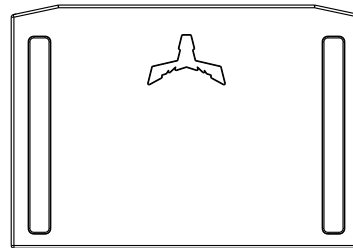
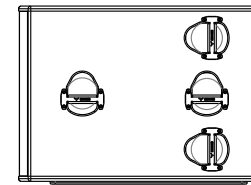
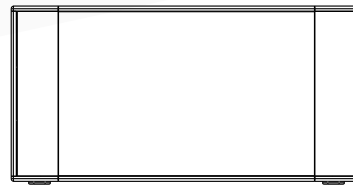
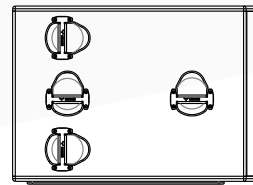
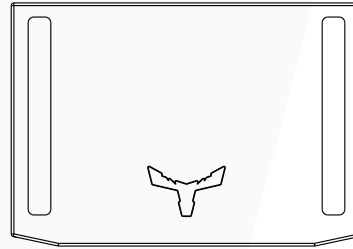
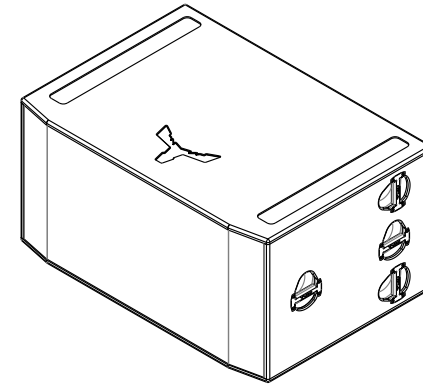
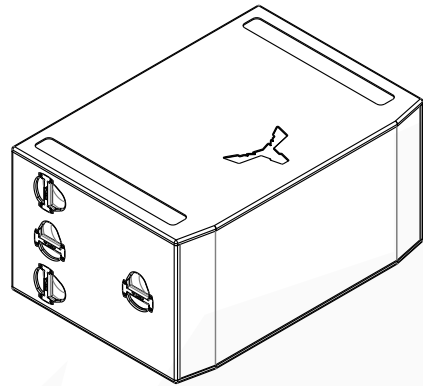
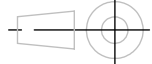

	Tolerâncias	ISO 2768 CLASSE - M	Revisão		Cliente	
	Espessura		Substitui		Nome do desenho	
Ref.º do Aparelho	Material		Unidades	mm	G218	
XXXX	Páginas	1 / 1	Cor			
Des. nº.	Nome do ficheiro				desenhou	aprovou
DSS	Localização				data	
					nome	

PROFACTOR