

DD800

Presentation:

Super-efficient class D technology amplifiers developed to deliver high output power and proven reliability for touring and portable applications.

The DLINE series amplifiers are designed to meet the specialized needs of sound contractors. Four models have been developed to deliver high output power, wide dynamic range, low distortion, high efficiency and ease of use for a wide variety of sound reinforcement applications.

There are two models of 2-channel plus two models of 4-channel all prepared to work @2ohm with front panel LEDs to monitor power, signal and clipping at a glance and parallel XLR/M and XLR/F connectors for simple loop-through connectivity.

The series applies classical PWM circuit design and new technology protection circuit, high stability and usability, high efficiency SMPS and big current storage, intelligent limiter, multi-protection functions built for demanding environments packed in a Rack 19" - 1U lightweight enclosure. The DLINE series amplifiers are powerful, affordable, rugged and reliable, a superior solution to any portable or permanent installation.

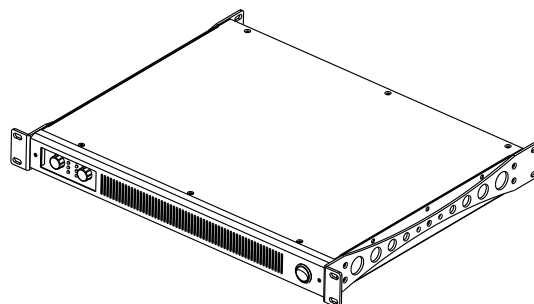

Features:

- High quality and reliable class D amplifier series
- Classical PWM circuit design and new technology
- Output power @ 8ohm: 2x 300W
- Output power @ 4ohm: 2x 400W
- XLR/F input connectors and Speakon 4p outputs
- Modular design, no interference between channels
- Front panel LEDs to monitor power, signal and clipping
- Integrated protection circuitry to protect amplifier and speakers
- Solid construction for 19" Rack - 1U lightweight enclosure

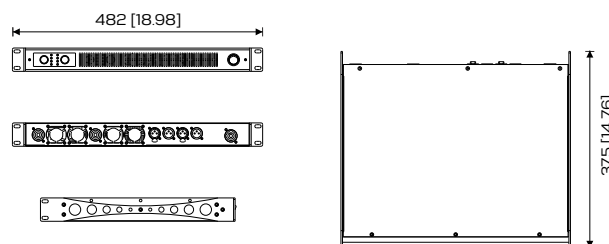

Dimensions in mm [in]

Technical specifications:

Type	Professional class D amplifier
No. of channels	2
RMS Power @ 8ohm	2x 300W (1kHz / 0.1%)
RMS Power @ 4ohm	2x 400W (1kHz / 0.1%)
Frequency Range	20Hz - 20kHz, ± 0.3 dB
T.H.D.	< 0.3%
Damping Factor	> 800 (8 Ω , 20Hz-200Hz)
Crosstalk	> 75dB
S/N ratio	> 105dB
Input sensitivity	20k Ω (balanced), 10k Ω (unbalanced)
Controls	Mains switch (on/off), 4x volume, Power on: Green; Signal: Green;
Indicators	Clip/Protect: Red (1 per channel)
Inputs	XLR/F 3p connectors
Outputs	Speakon 4p connectors
AC connectors	PowerCON AC input
Protections	Thermal overload, DC protection, short circuit, clip limiter, temperature control
Operating Voltage	220-240V AC (factory configured), 50-60 Hz
Power consumption	2000VA
Cooling	Continuous speed fan, automatic
Dimensions	1RU space, 375mm depth (14.76in)
Weight	5.6Kg 12.34lb

