

Base de dados:	Guilhotina:
Ordem:	Quinadora:
Referência:	Puncionadora:

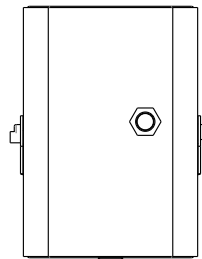
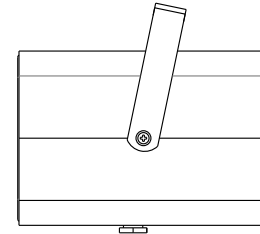
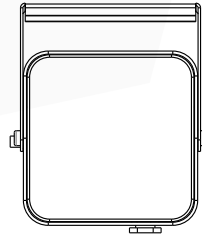
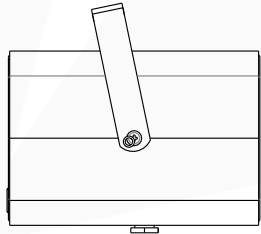
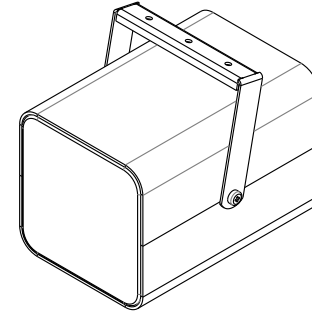
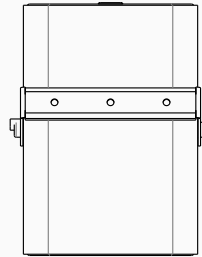
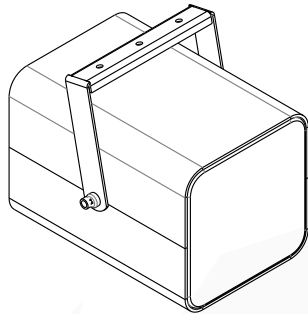

	Tolerâncias	ISO 2768 CLASSE - M	Revisão		Cliente		
	Espessura		Substitui		Nome do desenho		
Ref.º do Aparelho	Material		Unidades	mm	<b>WX24</b>		
<b>XXXX</b>	Páginas	1 / 1	Cor				
Des. nº.	Nome do ficheiro				desenhou	aprovou	
<b>DSS</b>	Localização				data		
					nome		

**PROFACTOR**